

# ASSEMBLY INSTRUCTIONS

Conversion Kit  
GEORGETOWN  
Model # 11670

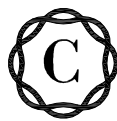
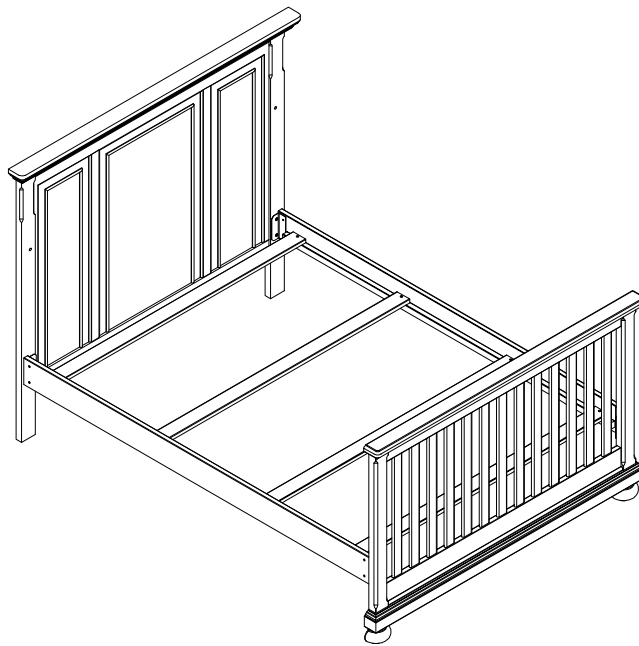

CENTENNIAL

- THE PRODUCT IMAGES SHOWN ARE FOR ILLUSTRATION PURPOSES ONLY AND MAY NOT BE AN EXACT REPRESENTATION OF THE PRODUCT.
- FINISH COLOR MAY VARY SLIGHTLY DUE TO DIFFERENCES IN WOOD TYPES.

" RECOMMENDATION: We recommend the use of a Bunkie Board or box spring under a mattress for this conversion kit."

Carefully remove and lay out all parts. Familiarize yourself with all exhibits and diagrams to facilitate the assembly of your crib

**TOOLS REQUIRED :**

Allenkey (supplied )

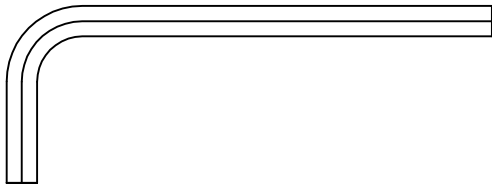

Screw Driver (Unsupplied )

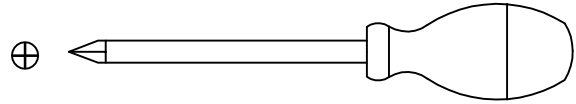

**PART ENCLOSED IN CARTON**

A. Rails (2 pcs )

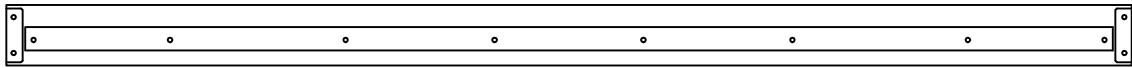

B. Slat (4 pcs )

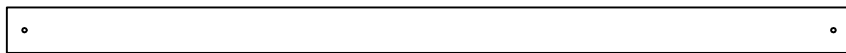

**HARDWARE**

C. Allenbolt 1 1/4" (30 mm ) (4 pcs)



L. Nut 3/4" (20 mm) (6 pcs)

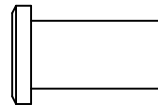

D. Allenbolt 3/4" (20 mm ) (6 pcs)



W. Spring Washer (8 pcs )

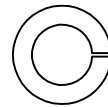

G. Screw 1 1/4" (30 mm) (8 pcs )

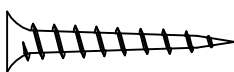

N. Allenkey ( 2 pcs ) (length may vary )



Make sure the bolts are tightly locked against the washers during assembly.  
(Please add an extra 1/2 revolution to all the bolts when using spring washer after tightening)

# STEP 1 " ASSEMBLY OF HEAD BOARD "

## THIS STEP REQUIRES :

Headboard (1 pc )

A. Rails (2 pcs )

N. Allenkey (2 pcs )

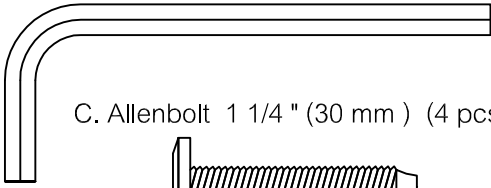

C. Allenbolt 1 1/4 " (30 mm ) (4 pcs )

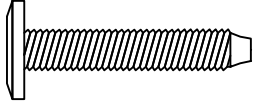

W. Spring Washer (4 pcs )

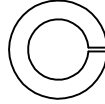

L. Nut 3/4" (20 mm ) (4 pcs )

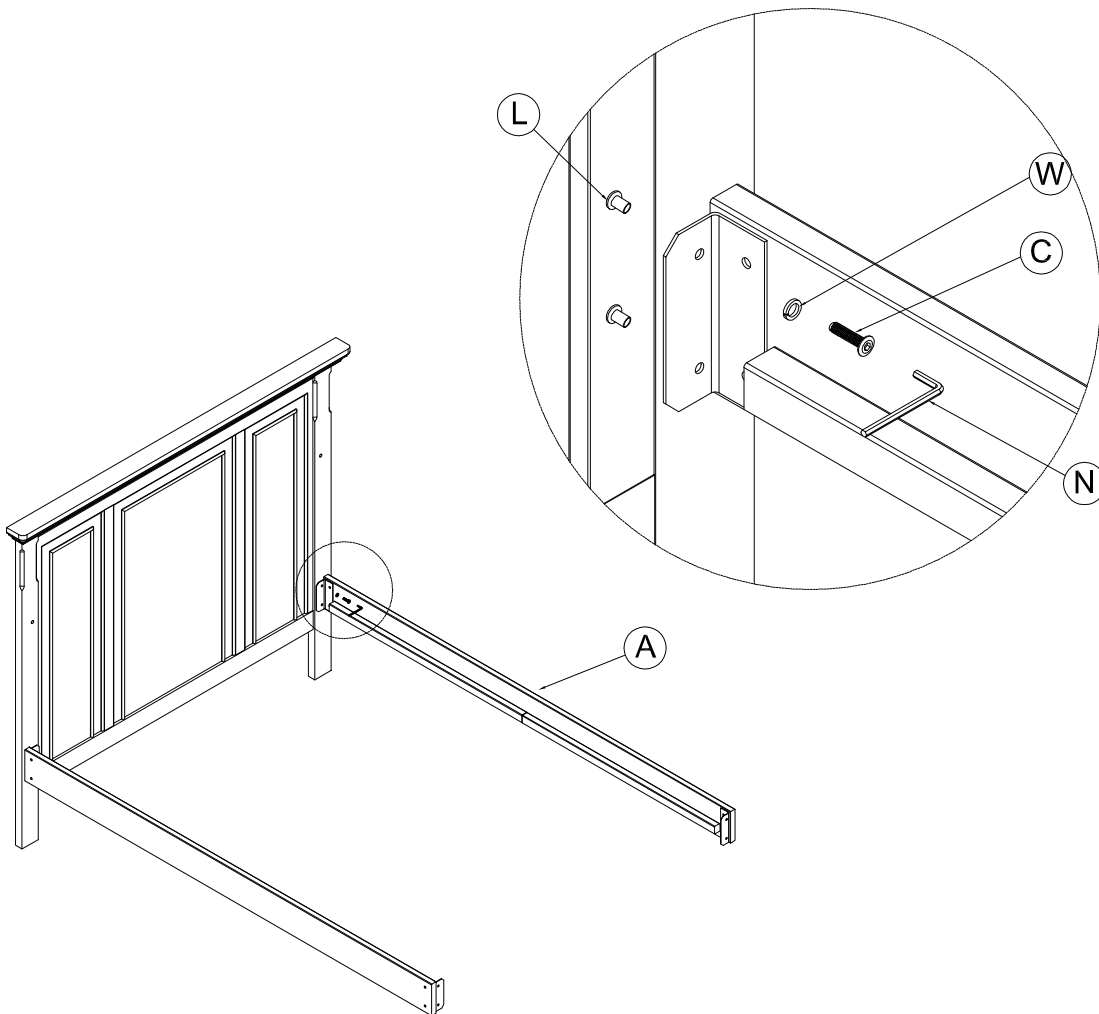
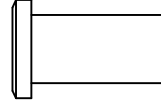

- Insert Allenbolt 1 1/4 " (30 mm ) (C) with spring washer (W) through the metal bracket holes in the end of side rail through the top & bottom holes in headboard and connect with nut 3/4" (20 mm ) (L).  
Hand tighten only.

## STEP 2 " ASSEMBLY OF FOOTBOARD "

### THIS STEP REQUIRES :

Footboard (1 pc)

N. Allenkey (2 pcs)

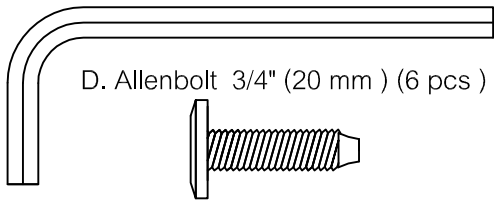

L. Nut 3/4" (20 mm ) (2 pcs )

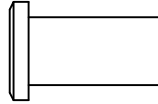

W. Spring Washer (4 pcs )

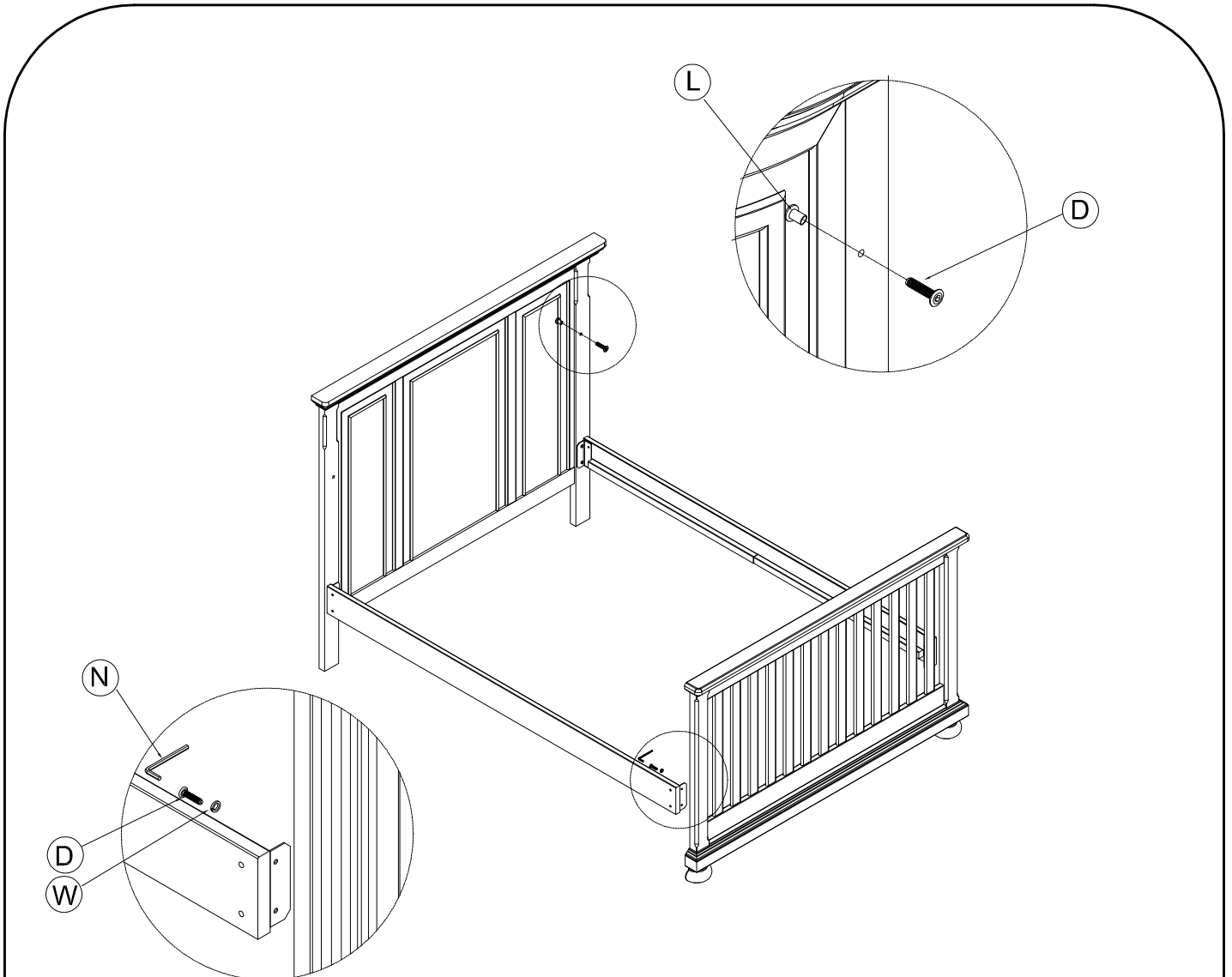
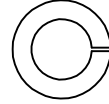

- Insert Allenbolt 3/4" (20 mm) (D) with spring washer (W) through the metal bracket holes in the end of side rail through the threaded holes in the footboard.
- Tighten all bolts with allenkey (N).
- Insert Allenbolt 3/4" (20 mm) (D), through the top hole in the headboard from the inside and connect with nut 3/4" (20 mm) (L). Tighten all bolts and nuts with allenkey (N).

## STEP 3 " ASSEMBLY OF SLATS "

### THIS STEP REQUIRES :

B. Slats (4 pcs)

G. Screw 1 1/4" (30 mm) (8 pcs)

Screw Driver  
(Unsupplied)

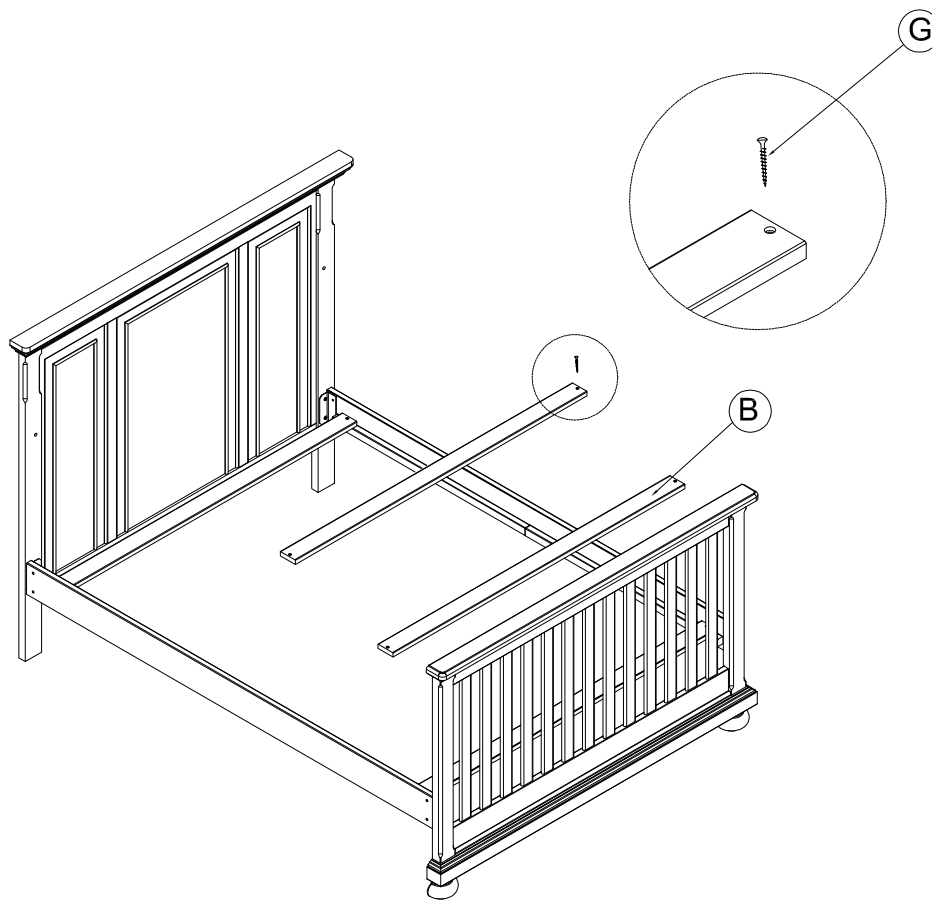
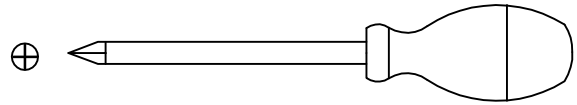
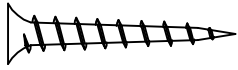

- Install 4 pcs of slats (B) to the 2 pcs of side rail above the pre drilling holes.
- Insert 8 pcs of screw 1 1/4" (30 mm) (G) screws into the slats holes through side rail pre drilling holes. Hand tighten only
- After all 8 pcs of screw inserted, fasten with screw driver.